



# RNG-50D-SS

## 50W Monocrystalline Solar Panel

### Key Features

Sleek design and a durable frame, the Renogy 50 Watt 12 Volt Monocrystalline Panel provides you with the most efficiency per space and is the perfect item for off-grid applications.

- High module conversion efficiency
- Top ranked PTC rating
- Quick and inexpensive mounting
- 100% EL testing on all Renogy modules
- No hot spots guaranteed

### Potential Uses

The Renogy 50 Watt Monocrystalline Panel can be used in various off-grid applications that include 12 and 24 volts arrays, water pumping systems, signaling systems and other off-grid applications.



Power Output Warranty



Material and Workmanship Warranty

# RNG-50D-SS

## 50W Monocrystalline Solar Panel

### Electrical Data

Maximum Power at STC*	50 W
Optimum Operating Voltage ( $V_{mp}$ )	18.3 V
Optimum Operating Current ( $I_{mp}$ )	2.90 A
Open Circuit Voltage ( $V_{oc}$ )	21.8 V
Short Circuit Voltage ( $I_{sc}$ )	3.10 A
Cell Efficiency	21.0%
Maximum System Voltage	600 VDC UL
Maximum Series Fuse Rating	15 A

### Thermal Characteristics

Operating Module Temperature	-40°C to +90°C
Nominal Operating Cell Temperature (NOCT)	47±2°C
Temperature Coefficient of Pmax	-0.44%/°C
Temperature Coefficient of Voc	-0.30%/°C
Temperature Coefficient of Isc	0.04%/°C

### Junction Box

IP Rating	IP 65
Diode Type	HY 10SQ050
Number of Diodes	1 Diode(s)
Output Cables	12 AWG (1.31 ft long)

### Module Diagram

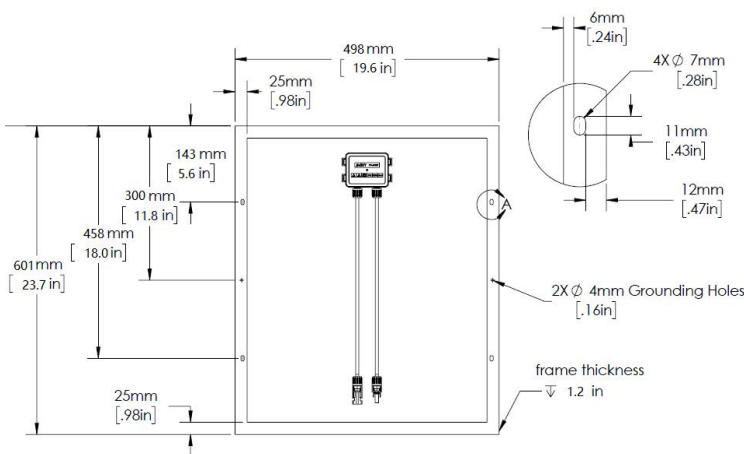

### Mechanical Data

Solar Cell Type	Monocrystalline (6.1 x 2.0 in)
Number of Cells	33 (3 x 11)
Dimensions	23.7 x 19.6 x 1.2 in (601 x 498 x 30 mm)
Weight	8.8 lbs (4.0 kg)
Front Glass	Tempered Glass 0.13 in (3.2 mm)
Frame	Anodized Aluminium Alloy
Connectors	MC4 Connectors
Fire Rating	Class C

### MC4 Connectors

Rated Current	30A
Maximum Voltage	1000VDC
Maximum AWG Size Range	10 AWG
Temperature Range	-40°F to 194°F
IP Rating	IP 67

### Certifications



### IV-Curve

RNG-50D-SS Characteristics Versus Voltage

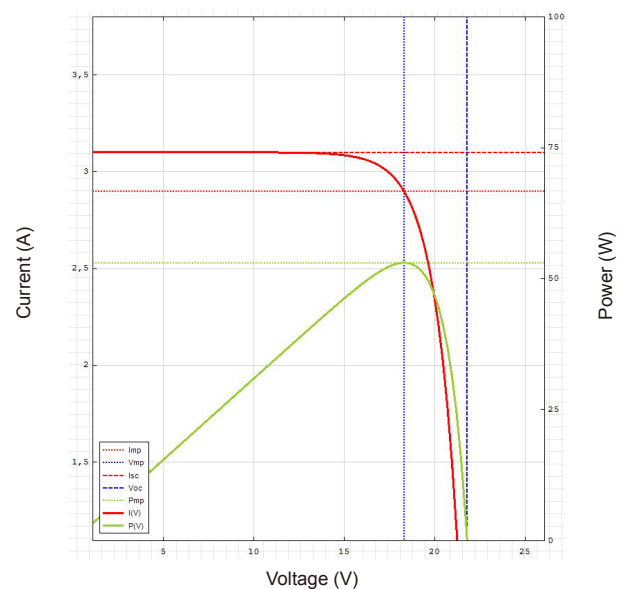

\*All specifications and data described in this data sheet are tested under Standard Test Conditions (STC - Irradiance: 1000W/m<sup>2</sup>, Temperature: 25 °C, Air Mass: 1.5) and may deviate marginally from actual values. Renogy and any of its affiliates has reserved the right to make any modifications to the information on this data sheet without notice. It is our goal to supply our customers with the most recent information regarding our products. These data sheets can be found in the downloads section of our website, [www.renogy.com](http://www.renogy.com)