

# RENOGY Core Series

## Deep Cycle Lithium Iron Phosphate Battery

12.8V | 200Ah

RBT12200LFP-US

VERSION A0

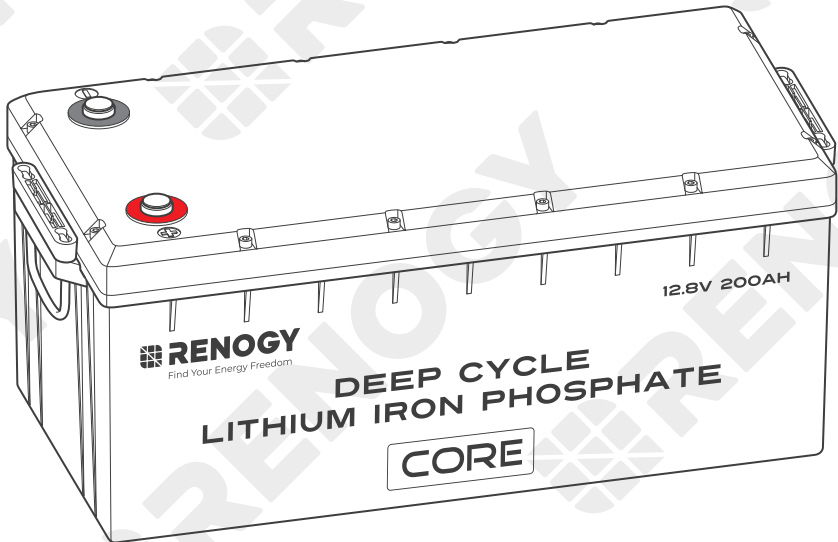

USER MANUAL

## Before Getting Started

The user manual provides important operation and maintenance instructions for Renogy Core Series 12.8V 200Ah Deep Cycle Lithium Iron Phosphate Battery (hereinafter referred to as battery).

Read the user manual carefully before operation and save it for future reference. Failure to observe the instructions or precautions in the user manual can result in electrical shock, serious injury, or death, or can damage the battery, potentially rendering it inoperable.

- Renogy ensures the accuracy, sufficiency, and the applicability of information in the user manual at the time of printing due to continual product improvements that may occur.
- Renogy assumes no responsibility or liability for personal and property losses, whether directly and indirectly, caused by the user's failure to install and use the product in compliance with the user manual.
- Renogy is not responsible or liable for any failure, damage, or injury resulting from repair attempts by unqualified personnel, improper installation, or inappropriate operation.
- The illustrations in the user manual are for demonstration purposes only. Details may appear slightly different depending on product revision and market region.
- Renogy reserves the right to change the information in the user manual without notice. For the latest user manual, visit [renogy.com](https://www.renogy.com).

## Disclaimer

Renogy Core Series 12.8V 200Ah Deep Cycle Lithium Iron Phosphate Battery User Manual © 2023 Renogy. All rights reserved.

**RENOGY** and **RENOGY** are registered trademarks of Renogy.

- All information in the user manual is subject to copyright and other intellectual property rights of Renogy and its licensors. The user manual may not be modified, reproduced, or copied, in whole or in part, without the prior written permissions of Renogy and its licensors.
- The registered trademarks in the user manual are the property of Renogy. The unauthorized use of the trademarks is strictly prohibited.

## Online Manual



User Manual



# Table of Contents



<b>Symbols Used</b> .....	1
<b>Introduction</b> .....	1
<b>Key Features</b> .....	1
<b>SKU</b> .....	1
<b>What's In the Box?</b> .....	2
<b>Required Tools &amp; Accessories</b> .....	2
<b>Get to Know Deep Cycle Lithium Iron Phosphate Battery</b> .....	3
<b>Dimensions</b> .....	3
<b>How to Size Battery Adapter Cables?</b> .....	4
<b>Fix the Battery to a Position (Optional)</b> .....	4
<b>Step 1. Plan a Mounting Site</b> .....	5
<b>Step 2. Wear Insulating Gloves</b> .....	5
<b>Step 3. Remove the Dust Cover.</b> .....	6
<b>Step 4. Check the Battery</b> .....	6
<b>Step 5. Run the Battery Adapter Cables Through the Insulating Sleeves</b> .....	6
<b>Step 6. Install Battery Terminals</b> .....	7
<b>Step 7. Install the Insulating Sleeves</b> .....	7
<b>Step 8. Connect the Battery to Other Devices</b> .....	8
<b>How to Connect Renogy Core Batteries in Series or Parallel</b> .....	9
Calculate Voltage and Current in Series and Parallel Connections .....	9
Balance Batteries Prior to Connection .....	9
Series Connection vs. Parallel Connection — Installation Steps .....	10
Battery Cell Balancing .....	12
<b>Charging/Discharging Parameter Settings</b> .....	13
<b>Battery Charging and Discharging Logic</b> .....	13
Charging Logic .....	13
Discharging Logic .....	14
<b>How to Estimate the Battery SOC?</b> .....	14
<b>Battery Management System</b> .....	14
<b>Troubleshooting</b> .....	15
<b>Specifications</b> .....	16
General .....	16
Operation Parameters .....	16

<b>Maintenance &amp; Storage</b> .....	<b>17</b>
Inspection.....	17
Cleaning.....	17
Checking Voltage.....	17
Storage.....	17
<b>Important Safety Instructions</b> .....	<b>18</b>
General .....	18
Battery Safety.....	18
<b>Renogy Support</b> .....	<b>19</b>



## Symbols Used

The following symbols are used throughout the user manual to highlight important information.

-  **WARNING:** Indicates a potentially dangerous condition which could result in injury or death.
-  **CAUTION:** Indicates a critical procedure for safe and proper installation and operation.
-  **NOTE:** Indicates an important step or tip for optimal performance.

## Introduction

The Renogy Core Series 12.8V 200Ah Deep Cycle Lithium Iron Phosphate Battery is designed for the drop-in replacement of deep-cycle lead-acid batteries with its standard Battery Council International (BCI) group size.

Weighing only half of the lead-acid counterparts, the battery can be safely discharged to 100% Depth of Discharge (DOD), delivering twice the energy. Manufactured with automotive grade battery cells, the battery features the highest safety standards and an extended 5000+ cycle life. In addition, the reliable Battery Management System (BMS) provides comprehensive protection to the battery.

## Key Features

- **Unparalleled Performance**  
Features a greater energy density, a deeper discharge capability, a higher round-trip efficiency, and a faster charging speed in a smaller size over counterparts in the market.
- **Uncompromising Quality**  
Ensures an exceptional lifespan with more than 5000 cycles (80% DOD), a continuous charge current of 100A and a continuous discharge current of 200A, and a wide range of operating temperatures with the automotive grade battery cells.
- **Reliable Protection Mechanisms**  
Designed with a sturdy internal structure for RV use, and includes multiple levels of protection such as low temperature cut-off and precise balancing through the battery management system.
- **Higher Capacity than Competitors**  
212Ah instead of 200Ah, for a longer-lasting application.
- **Easy to Expand**  
Upgrades to lithium batteries seamlessly with the standard BCI group sizes; up to 16 batteries in 4 series and 4 parallels system connection delivering a maximum of 48V (51.2V) 800Ah with 40.96 kWh.

## SKU

Renogy Core Series 12.8V 200Ah Deep Cycle Lithium Iron Phosphate Battery

RBT12200LFP-US

## What's In the Box?

Renogy Core Series 12.8V 200Ah Deep Cycle  
Lithium Iron Phosphate Battery × 1

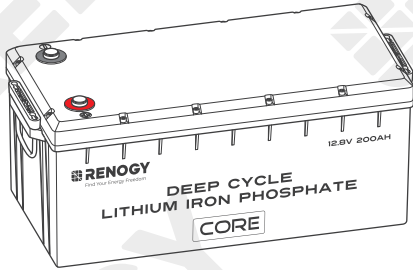

User Manual × 1

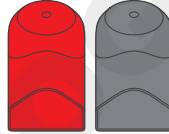

Insulating Sleeve × 2

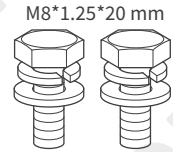

Long Terminal Bolt × 2

**i** Make sure that all accessories are complete and free of any signs of damage.

## Required Tools & Accessories

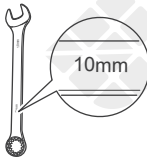

Wrench (7/16 inches)

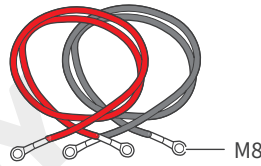

Battery Adapter Cables × 2

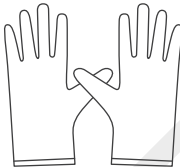

Insulating Gloves

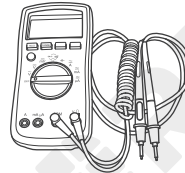

Multimeter

**i** Prior to installing and configuring the battery, prepare the recommended tools, components, and accessories.

**i** For how to size battery adapter cables, refer to "[How to Size Battery Adapter Cables?](#)" in this manual.

## Get to Know Deep Cycle Lithium Iron Phosphate Battery

Negative Terminal (M8)

Positive Terminal (M8)

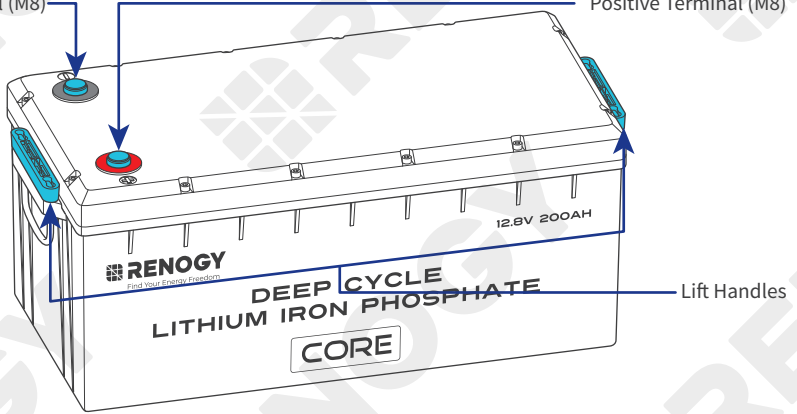

## Dimensions

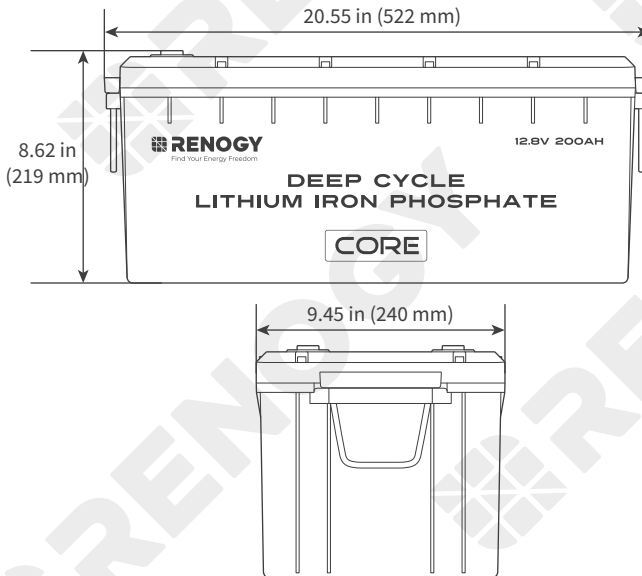

**i** Dimension tolerance:  $\pm 0.2$  in (0.5 mm)

## How to Size Battery Adapter Cables?

Use appropriately sized Battery Adapter Cables (sold separately) based on expected load. Refer to the table below for copper cable ampacities with different gauge sizes.

Cable Gauge Size	Ampacity	Cable Gauge Size	Ampacity
14 AWG (2.08 mm <sup>2</sup> )	35A	2 AWG (33.6 mm <sup>2</sup> )	190A
12 AWG (3.31 mm <sup>2</sup> )	40A	1 AWG (42.4 mm <sup>2</sup> )	220A
10 AWG (5.25 mm <sup>2</sup> )	55A	1/0 AWG (53.5 mm <sup>2</sup> )	260A
8 AWG (8.36 mm <sup>2</sup> )	80A	2/0 AWG (67.4 mm <sup>2</sup> )	300A
6 AWG (13.3 mm <sup>2</sup> )	105A	4/0 AWG (107 mm <sup>2</sup> )	405A
4 AWG (21.1 mm <sup>2</sup> )	140A		

**i** The above values are from the NEC Table 310.17 for copper cables rated at 194°F (90°C), operating at an ambient temperature of no more than 86°F (30°C). Cables longer than 13 feet (4000 mm) may require thicker gauge wires to prevent excessive voltage drop in undersized wiring.

## Fix the Battery to a Position (Optional)

Securing the battery prevents damage to the battery from loose cables and bumps.

### Recommended Components

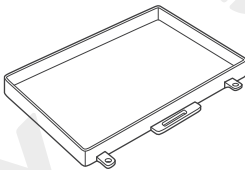

Battery Tray

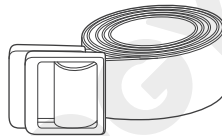

Tie Down Strap



Mounting Screws × 4

**i** Alternative mounting methods are allowed to meet the requirements of specific applications.

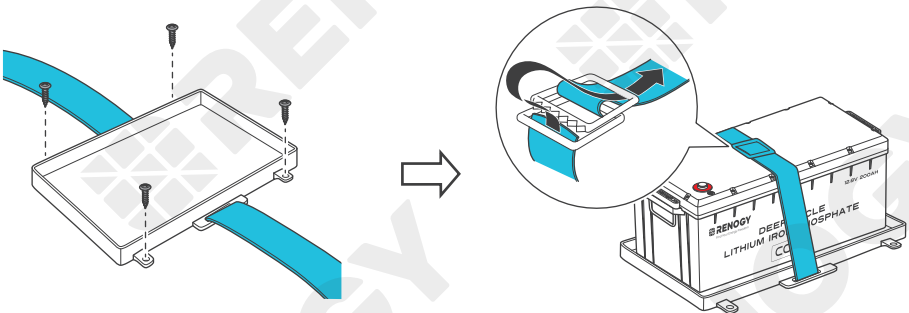

## Step 1. Plan a Mounting Site

For optimal battery performance, it is recommended to install the battery in a clean, cool, and dry location, free from any accumulation of water, oil, or dirt. Accumulation of such materials on the battery can lead to current leakage, self-discharge, and even short-circuiting.

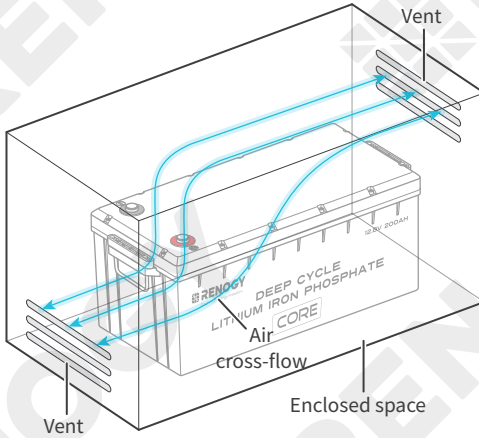

 Charge: 32°F–131°F / 0°C–55°C  
Discharge: -4°F–140°F / -20°C–60°C

 10%–95%

 Sufficient air flow must be provided to prevent excessive heat build-up and to minimize temperature variation between the connected batteries.

 This user manual takes a battery as an example to illustrate how to install the battery.

## Step 2. Wear Insulating Gloves

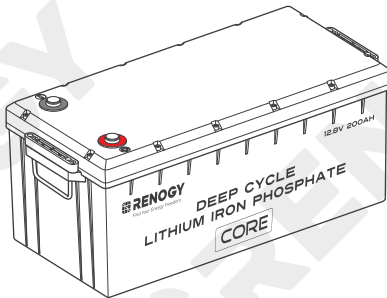

Insulating Gloves



### Step 3. Remove the Dust Cover.

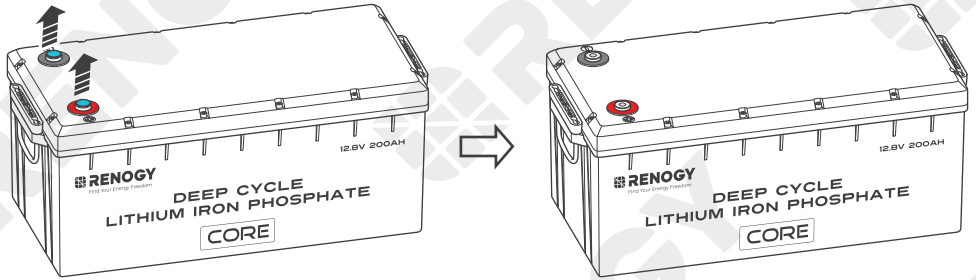

### Step 4. Check the Battery

Inspect the battery for any visible damage including cracks, dents, deformation, and other visible abnormalities. All connector contacts shall be clean, free of dirt and corrosion, and dry.

- ⚠ Do not touch the exposed electrolyte or powder if the battery is damaged.
- ⚠ If uncovered electrolyte or powder contacts your skin or eyes, flush it out immediately with plenty of clean water and seek medical attention.

### Step 5. Run the Battery Adapter Cables Through the Insulating Sleeves

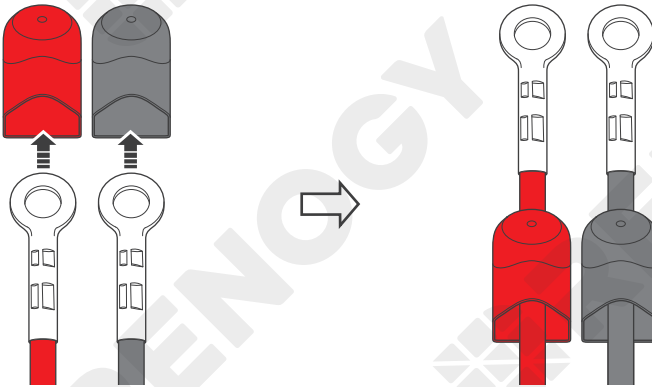

## Step 6. Install Battery Terminals

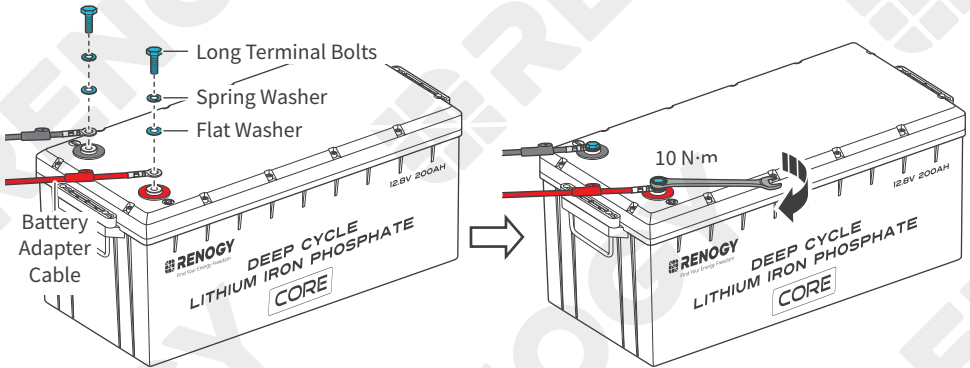

- ⚠️ Ensure the cable lug and the top surface of the terminal are in contact, and place the washers on top of the lug. Do not place the washers between the battery terminal and the cable lug to avoid high resistance and excessive heating.
- ⚠️ Avoid short-circuiting the battery terminals to prevent irreversible damage to the system and battery caused by current bursts.
- ⚠️ Verify polarity before wiring to avoid irreversible battery damage due to polarity reversal.
- ℹ️ To ensure safe and reliable operation of the system, please follow the manufacturer's recommended torque specifications when securing cable connections. Over-tightening can result in terminal breakage, while loose connections can lead to terminal meltdown or fire. When securing multiple cable lugs on a single battery terminal, use the included Long Terminal Bolts.

## Step 7. Install the Insulating Sleeves

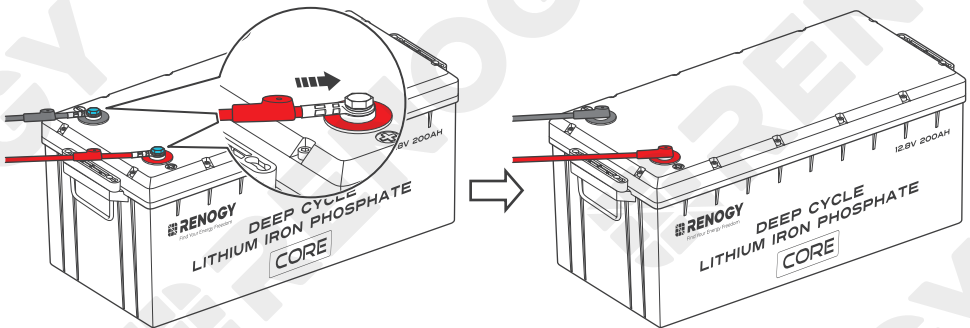

## Step 8. Connect the Battery to Other Devices

**⚠** Please use circuit breakers, fuses, or disconnects appropriately sized by a certified electrician, licensed installers, or regional code authorities to protect all electrical equipment.

### For a Single Battery

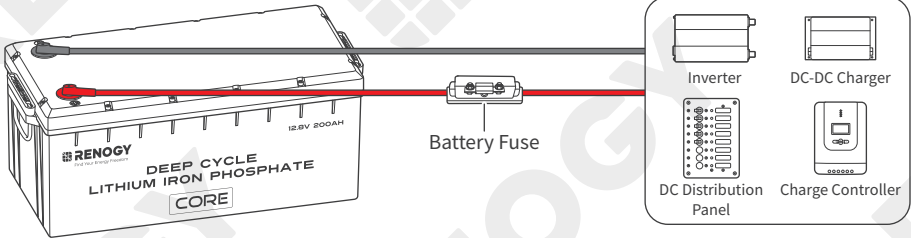

### For Batteries in Parallel

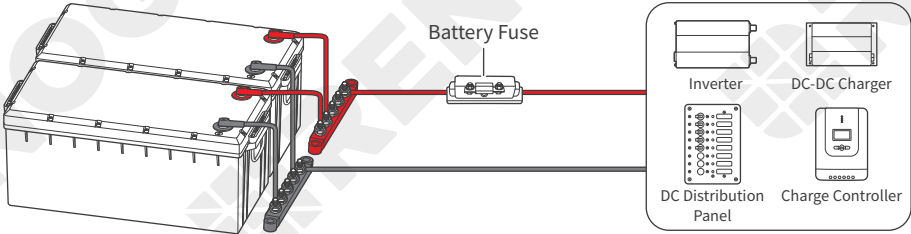

### For Batteries in Series

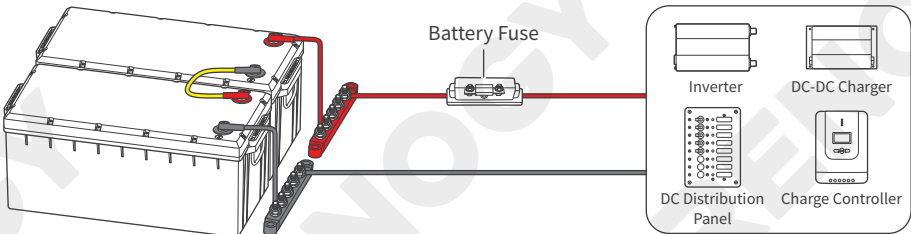



# How to Connect Renogy Core Batteries in Series or Parallel

## Calculate Voltage and Current in Series and Parallel Connections

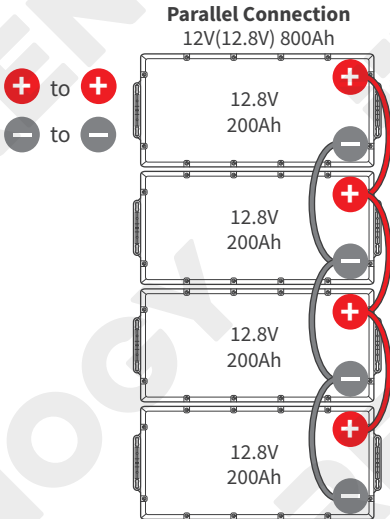

System Voltage	System current
12.8V	Sum of the individual battery currents

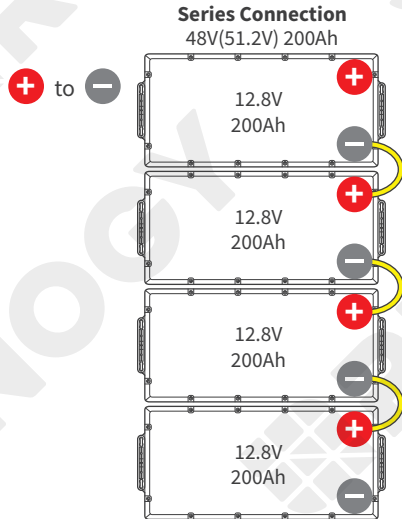

System Voltage	System current
Sum of the individual battery voltages	200A

- ⚠ Do not connect batteries with different chemistries, rated capacities, nominal voltages, brands, or models in parallel or in series. This can result in potential damage to the batteries and the connected devices, and can also pose safety risks.
- ⚠ Avoid connecting batteries that have been purchased for more than half a year. Over time, batteries can degrade and their performance may decrease, which can affect their ability to deliver reliable power and may lead to safety hazards.
- ⚠ The cables between each connected battery should be of equal length to ensure that all batteries can work equally together.
- ℹ You can connect up to 8 batteries in parallel or 4 batteries in series.

## Balance Batteries Prior to Connection

Before connecting batteries in series or parallel, it is important to balance them to reduce voltage differences and optimize their performance. Follow these three steps:

**Step 1:** Charge each battery individually to its full capacity using a suitable charger.

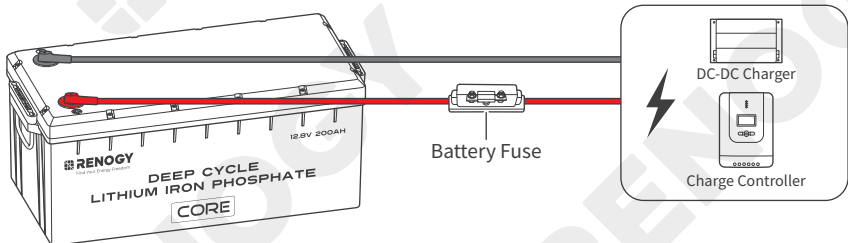

**Step 2:** Use a voltmeter to measure the voltage of each battery. It is best to keep the voltage difference of each battery less than 0.1V.

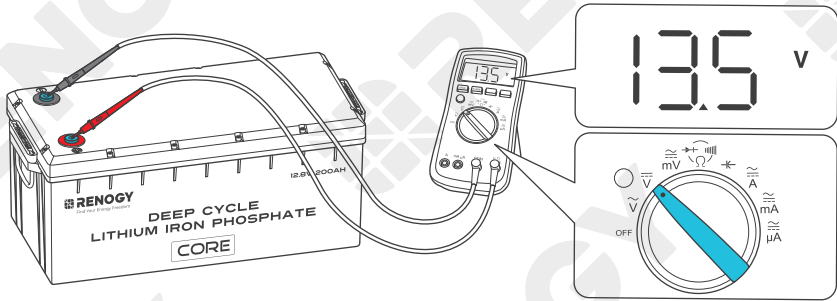

**Step 3:** Connect all the batteries in parallel and allow them to rest together for 12 to 24 hours.

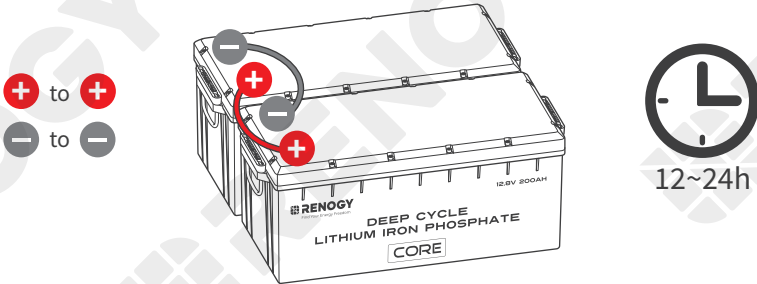

**i** It is recommended to periodically rebalance the battery voltages every six months when connecting multiple batteries as a battery system. Slight voltage differences can occur among batteries over time due to factors like battery chemistry, capacity, temperature, and usage patterns.

### Series Connection vs. Parallel Connection – Installation Steps

**!** You can choose suitable busbars in series and parallel connections. Busbars help handle high currents and are typically arranged in a parallel or stacked configuration to distribute electrical power efficiently.

**i** Note that the cable connection methods provided below are for reference purposes only, as the optimal approach may vary depending on the specific situation. It is essential to consider various factors, such as the cable size, equipment used, and environmental conditions.

#### Parallel Connection

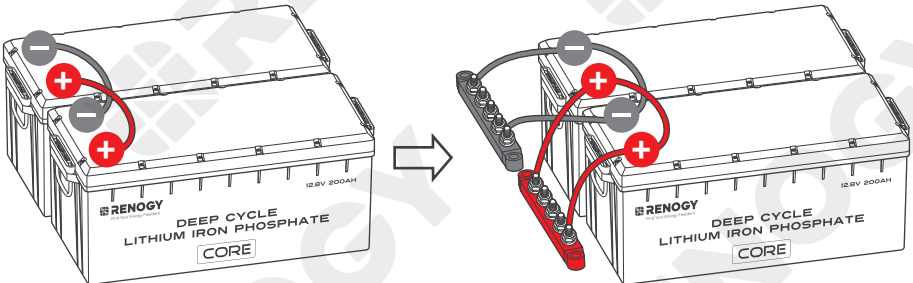

<b>2P</b>	Battery System	12V (12.8V) 400Ah
	Energy	5120Wh
<b>8P</b>	Battery System	12V (12.8V) 1600Ah
	Energy	20480Wh

**Series Connection**

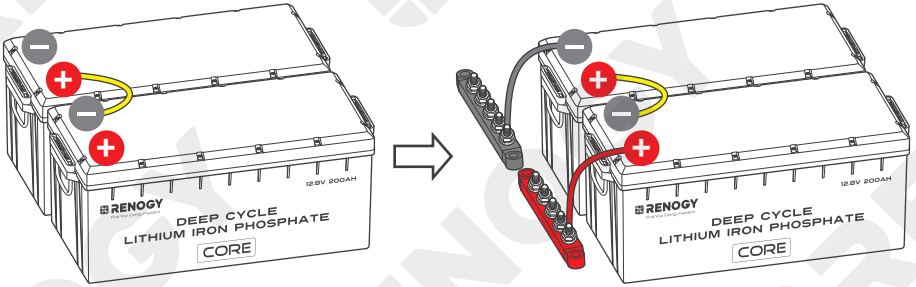

<b>2S</b>	Battery System	24V (25.6V) 200Ah
	Energy	5120Wh
<b>4S</b>	Battery System	48V (51.2V) 200Ah
	Energy	10240Wh

**Parallel & Series Connection**

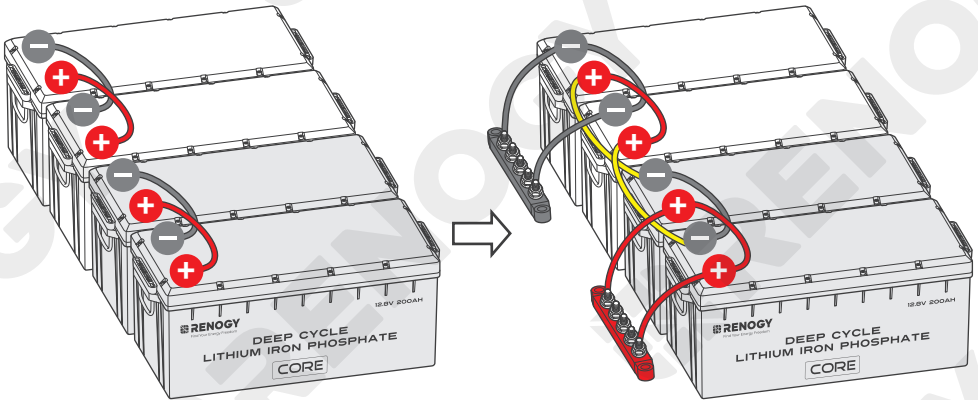

<b>2P2S</b>	Battery System	24V (25.6V) 400Ah
	Energy	10240Wh

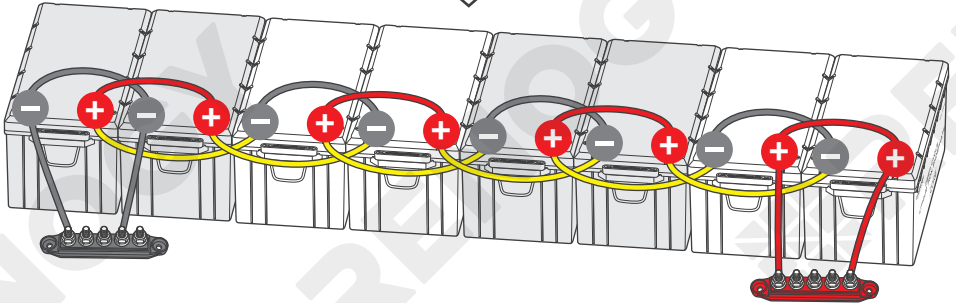
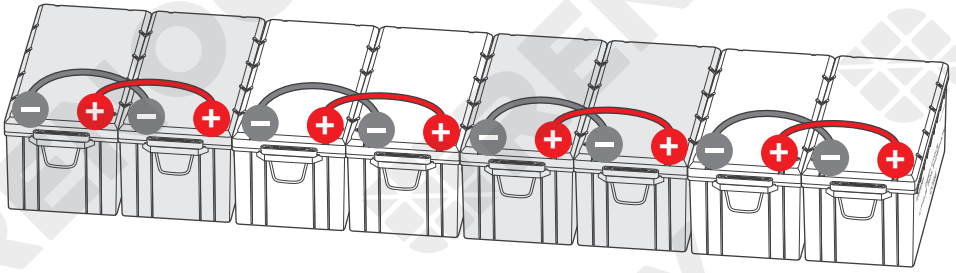

<b>2P4S</b>	Battery System	48V (51.2V) 400Ah
	Energy	20480Wh

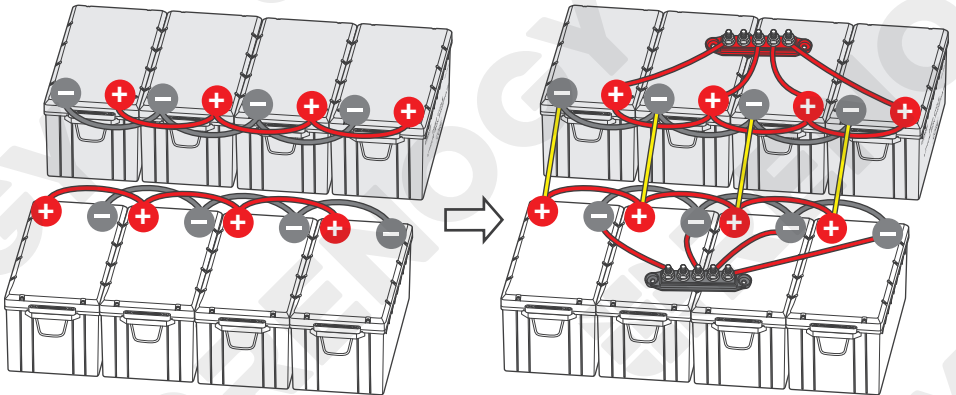

<b>4P2S</b>	Battery System	24V (25.6V) 800Ah
	Energy	20480Wh

### Battery Cell Balancing

The battery employs bypass circuit to maintain the balance between each battery cell group. Each battery cell group is connected with a bypass resistor and a switch in parallel. During the charging process, if the highest-voltage battery cell group reaches the set balancing starting voltage and the voltage difference between the highest-voltage and the lowest-voltage battery cell group exceeds the set voltage difference, the switch connected to the highest-voltage battery cell group will be closed to shunt the charge current around the

highest-voltage battery cell group through the bypass resistor until the voltage difference drops below the set value. To avoid excessive energy loss, the battery cell balancing is only performed during the charging process.

## Charging/Discharging Parameter Settings

### ■ Charge

<b>Charge/Boost Voltage</b>	14.4V	<b>Boost Return Voltage</b>	13.2V
<b>Bulk/Absorption Voltage</b>	14.4V	<b>Overvoltage Disconnect</b>	15.0V
<b>Bulk/Absorption Voltage</b>	14.4V / Disabled	<b>Overvoltage Reconnect</b>	14.2V

### ■ Discharge

<b>Low Voltage Reconnect</b>	12.6V	<b>Undervoltage Warning</b>	12.0V
<b>Undervoltage Shutdown</b>	10.0V		

**i** The parameters in the table are applicable to 12V (12.8V) battery packs. Please multiply by 2 for 24V (25.6V) packs and multiply by 4 for 48V (51.2V) packs.

## Battery Charging and Discharging Logic





The battery may be received at a partial state of charge (SOC) depending on the time between manufacturing and shipping. It is crucial to fully charge the battery before its initial use. In case the battery shuts off due to low SOC, promptly disconnect it from loads and charge it to prevent irreversible damage. Follow the instructions in this user manual for proper charging and usage to ensure optimal battery performance and longevity.

### Charging Logic

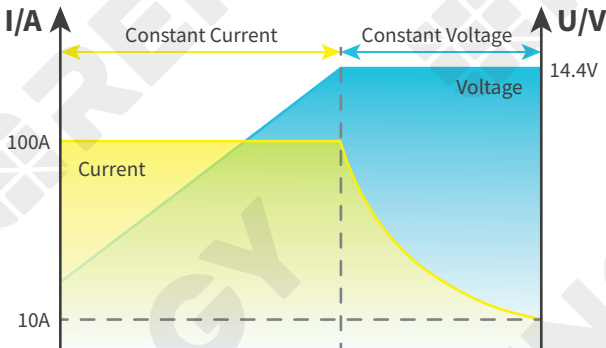
The standard charging process for the battery involves charging at a constant current of 100A until the battery voltage reaches 14.4V, followed by charging at a constant voltage of 14.4V while tapering the charge current. The charging process is considered complete when the charge current is less than 10A (also known as tail current).



The standard charging process typically takes 2.5 hours and requires battery temperatures to be between 32°F and 131°F (0°C and 55°C) for safe charging. Leaving the battery on float will continue to balance the battery cells without damaging the battery.



-  Lithium batteries are compatible with various charging methods, including MPPT charge controller, AC charger, and DC-DC charger. The crucial parameter setting for these chargers is to set the charge voltage, boost voltage, or bulk voltage at 14.4V ( $\pm 0.2V$ ).
-  Do not overcharge or overdischarge the battery.
-  Do not charge the battery at low temperatures below 32°F (0°C) and discharge the battery at high temperatures above 140°F (60°C).
-  Only charge the battery with a battery charger or charge controller that is compatible with lithium iron phosphate batteries.
-  Do not exceed the maximum continuous charge current (100A) of the battery.

## Discharging Logic

During standard discharging, the battery is discharged at a constant current of 100A until the voltage drops to 10V. To ensure safe discharging, the battery temperature should be between -4°F (-20°C) and 131°F (60°C).

-  To ensure safe and optimal battery usage, it is recommended to pair the battery with discharge equipment that features a low voltage disconnect (LVD) function.
-  Do not connect large loads to the battery when it is running low.
-  Do not exceed the maximum continuous discharge current (200A) of the battery.

## How to Estimate the Battery SOC?

The SOC values listed below are estimated based on the resting voltage when the battery is at rest for 30 minutes, not in charging or discharging state.

SOC	Charge Voltage	SOC	Charge Voltage
100%	13.6V	30%	12.9V
99%	13.4V	20%	12.8V
90%	13.2V	14%	12.7V
70%	13.1V	9%	12.6V
40%	13.0V	0%	10.0V

-  The table above is for reference only because slight variations in battery voltage may occur among different batteries.

## Battery Management System

The battery is equipped with a Battery Management System (BMS) that provides warnings and protections against overvoltage, undervoltage, overcurrent, short circuit, high temperature, and low temperature conditions. Refer to the table below for the triggering and recovery conditions of each warning and protection.

Battery Operating Status		Condition (For Reference Only)	
Battery Cell Overvoltage	Protection	Trigger	Battery Cell Voltage $\geq 3.75V$
		Recover	Battery Cell Voltage $\leq 3.55V$

Battery Operating Status		Condition (For Reference Only)	
Battery Cell Undervoltage	Protection	Trigger	Battery Cell Voltage $\leq 2.2V$
		Recover	Battery Voltage $\geq 2.7V$
Charge High Temperature	Protection	Trigger	Battery Temperature $\geq 126^{\circ}F$ ( $52^{\circ}C$ )
		Recover	Battery Temperature $\leq 113^{\circ}F$ ( $45^{\circ}C$ )
Discharge High Temperature	Protection	Trigger	Battery Temperature $\geq 149^{\circ}F$ ( $65^{\circ}C$ )
		Recover	Battery Temperature $\leq 122^{\circ}F$ ( $50^{\circ}C$ )
Charge Low Temperature	Protection	Trigger	Battery Temperature $\leq 32^{\circ}F$ ( $0^{\circ}C$ )
		Recover	Battery Temperature $\geq 41^{\circ}F$ ( $5^{\circ}C$ )
Charge Overcurrent	Protection	Trigger	Charge Current $\geq 140A$
		Recover	Discharge Current $\geq 1A$
Discharge Overcurrent	Protection	Trigger	Discharge Current $\geq 700A$
		Recover	Remove the load
Short Circuit	Protection	Trigger	Discharge Current $\geq 1000A$
		Recover	Remove Short Circuit

## Troubleshooting

Problem	Possible Causes	Solution
<ul style="list-style-type: none"> <li>The battery is unable to be activated with a charge/ discharge current greater than 1A</li> <li>The battery is activated at resting voltage below 10V</li> </ul>	Severe battery overdischarge due to self-discharge or parasitic loads	Revive the battery with a battery charger or charge controller featuring lithium battery activation or force charging.
The battery shuts off due to undervoltage protection.	The battery voltage drops below the preset threshold	Disconnect the battery from loads, and charge the battery with a current greater than 1A as soon as possible.
The battery cuts off the charging current due to overvoltage protection	The battery voltage exceeds the preset threshold during charging.	<ol style="list-style-type: none"> <li>Disconnect the battery from the charging source.</li> <li>Reduce charge voltage by 0.2V to 0.4V for 6 hours.</li> <li>Attempt to fully charge the battery again with the correct voltage setting. If the problem persists with a lithium iron phosphate compatible charging source and correct voltage setting, repeat the above steps.</li> </ol>

Problem	Possible Causes	Solution
The battery temperature gets too high/low during operation and triggers high/low temperature protection	The battery temperature exceeds the preset threshold.	<ol style="list-style-type: none"> <li>1. Disconnect the battery from the charging source or loads.</li> <li>2. Cool down/Warm up the battery.</li> <li>3. The battery recovers from high/low temperature protection automatically and continues operating.</li> </ol>
The battery is shorted and triggers short circuit protection.	Short circuit occurs in the battery.	<ol style="list-style-type: none"> <li>1. Remove the short circuit as soon as possible</li> <li>2. Charge the battery with a current greater than 1A.</li> </ol>
Charge/Discharge over-current protection is triggered due to too high current passing through the battery.	Excessive current flows through the battery during charging or discharging.	Disconnect the battery from the charging source or loads as soon as possible.

 For further assistance, contact Renogy technical support service at <https://www.renogy.com/contact-us>.

## Specifications

### General

<b>Battery Cell Type</b>	Lithium Iron Phosphate
<b>Rated Capacity (0.5C, 25°C)</b>	200Ah
<b>Nominal Voltage</b>	12.8V
<b>Voltage Range</b>	10V to 14.8V
<b>Cycle Life (0.5C, 25°C)</b>	5000 Cycles (80% DOD)
<b>Dimension</b>	20.55 x 9.45 x 8.62 in / 522 x 240 x 219 mm
<b>Weight</b>	47.3 lbs. / 21.45 kg
<b>Connection Method</b>	Series & Parallel (4S4P)
<b>Terminal Bolt Size</b>	M8 x 1.25 x 15 mm
<b>Recommended Terminal Torque</b>	88.5 inch-lbs to 106.2 inch-lbs / 10 N·m to 12 N·m
<b>Protection Rating</b>	IP65
<b>Certification</b>	MSDS, UN38.3, FCC, CE, PSE, and UKCA

### Operation Parameters

<b>Charge Voltage</b>	14.4V
<b>Maximum Continuous Charge Current</b>	100A
<b>Maximum Continuous Discharge Current</b>	200A
<b>Peak Discharge Current</b>	400A@10s



<b>Charge Temperature Range</b>	32°F to 131°F (0°C to 55°C)
<b>Discharge Temperature Range</b>	-4°F to 140°F (-20°C to 60°C)
<b>Storage Temperature Range</b>	-13°F to 149°F (-25°C to 65°C)
<b>Operation Relative Humidity</b>	10% to 95%

## Maintenance & Storage

### Inspection

Please perform regular inspections following the steps below:

- Examine the external appearance of the battery. The housing and terminals of the battery shall be clean, dry, and free of corrosion.
- Check battery cables and connections. Replace any damaged cables and tighten any loose connections.

**i** In certain application scenarios, corrosion may occur around the terminals. Corrosion can cause increased resistance and poor contact. It is recommended to regularly apply insulation grease to each terminal. Insulation grease can form a moisture-resistant seal and protect the terminals from corrosion.

### Cleaning

Please clean the battery at regular intervals following the steps below:

- Disconnect the battery from the system.
- Clear the leaves and debris from the battery.
- Clean the battery with a soft, lint-free cloth. The cloth can be dampened with water or mild soap and water if the battery is extremely dirty.
- Dry the battery with a soft, lint-free cloth.
- Keep the area around the battery clean.
- Reconnect the battery to the system.

### Checking Voltage

Please check the battery voltage periodically to assess battery health. If the battery is unable to be activated with a charge/discharge current greater than 1A or the battery is activated with a resting voltage below 10V, the battery may have been severely overdischarged due to self-discharge or parasitic loads. Please stop using the battery until the fault can be corrected and the battery can be charged.

### Storage

Please follow the tips below to ensure that the battery emerges from storage in a good condition:

- Charge the battery to 30% to 50% SOC.
- Disconnect the battery from the system.
- Store the battery in a well-ventilated, dry, clean area with temperatures between -13°F (-25°C) and 149°F (65°C).
- Do not expose the battery to direct sunlight, moisture, or precipitation.
- Handle the battery carefully to avoid sharp impacts or extreme pressure on the battery housing.
- Charge the battery at least once every 3 to 6 months to prevent it from overdischarge.
- Fully charge the battery when it is taken out of storage.

## Important Safety Instructions

The manufacturer accepts no liability for any damage caused by:

- Force majeure including fire, typhoon, flood, earthquake, war, and terrorism.
- Intentional or accidental misuse, abuse, neglect or improper maintenance, and use under abnormal conditions.
- Improper installation, improper operation, and malfunction of a peripheral device.
- Contamination with hazardous substances or radiation.
- Alterations to the product without express written consent from the manufacturer.

### General

- Wear proper protective equipment and use insulated tools during installation and operation. Do not wear jewelry or other metal objects when working on or around the battery.
- Keep the battery out of the reach of children.
- Do not dispose of the battery as household waste. Comply with local, state, and federal laws and regulations and use recycling channels as required.
- In case of fire, put out the fire with a FM-200 or CO<sub>2</sub> fire extinguisher.
- Do not expose the battery to flammable or harsh chemicals or vapors.
- Clean the battery regularly.
- It is recommended that all cables should not exceed 10 meters because excessively long cables result in a voltage drop.
- The cable specifications listed in the quick guide account for critical, less than 3% voltage drop and may not account for all configurations.
- Do not expose the battery to strong electrostatic fields, strong magnetic fields, or radiation.

### Battery Safety

- Please keep the battery away from water, heat sources, sparks, and hazardous chemicals.
- Do not puncture, drop, crush, burn, penetrate, shake, strike, or step on the battery.
- Do not open, dismantle, repair, tamper with, or modify the battery.
- Do not touch any terminals or connectors.
- Please make sure any battery charger or charge controller has been disconnected before working on the battery.
- Do not connect or disconnect terminals from the battery without first disconnecting loads.
- Do not place tools on top of the battery.
- Please use suitable handling equipment for safe transportation of the battery.
- Do not insert foreign objects into the positive and negative terminals of the battery.

## Renogy Support

To discuss inaccuracies or omissions in this quick guide or user manual, visit or contact us at:

 | [renogy.com/support/downloads](https://renogy.com/support/downloads)



 → [contentservice@renogy.com](mailto:contentservice@renogy.com)

For technical questions about your product in the U.S., contact the Renogy technical support team through:

 | [renogy.com/contact-us](https://renogy.com/contact-us)



1(909)2877111

For technical support outside the U.S., visit the local website below:

Canada |  | [ca.renogy.com](https://ca.renogy.com)

China |  | [www.renogy.cn](https://www.renogy.cn)

United Kingdom |  | [uk.renogy.com](https://uk.renogy.com)

Japan |  | [renogy.jp](https://renogy.jp)

Australia |  | [au.renogy.com](https://au.renogy.com)

Germany |  | [de.renogy.com](https://de.renogy.com)

South Korea |  | [kr.renogy.com](https://kr.renogy.com)

Other Europe |  | [eu.renogy.com](https://eu.renogy.com)

## FCC Statement

This device complies with Part 15 of the FCC Rules. Operation is subject to the following two conditions:

- (1) This device may not cause harmful interference, and
- (2) This device must accept any interference received, including interference that may cause undesired operation.

This equipment has been tested and found to comply with the limits for a Class B digital device, pursuant to Part 15 of the FCC Rules. These limits are designed to provide reasonable protection against harmful interference in a residential installation. This equipment generates uses and can radiate radio frequency energy and, if not installed and used in accordance with the instructions, may cause harmful interference to radio communications. However, there is no guarantee that interference will not occur in a particular installation. If this equipment does cause harmful interference to radio or television reception, which can be determined by turning the equipment off and on, the user is encouraged to try to correct the interference by one or more of the following measures:

- (1) Orient or relocate the receiving antenna.
- (2) Increase the separation between the equipment and receiver.
- (3) Connect the equipment into an outlet on a circuit different from that to which the receiver is connected.
- (4) Consult the dealer or an experienced radio/TV technician for help.

## FCC Radiation Exposure Statement

This equipment complies with FCC radiation exposure limits set forth for an uncontrolled environment. This equipment should be installed and operated with minimum distance 20cm between the radiator & your body.



## Renogy Empowered

Renogy aims to empower people around the world through education and distribution of DIY-friendly renewable energy solutions.

We intend to be a driving force for sustainable living and energy independence.

In support of this effort, our range of solar products makes it possible for you to minimize your carbon footprint by reducing the need for grid power.



## Live Sustainably with Renogy

Did you know? In a given month, a 1 kW solar energy system will...



Save 170 pounds of coal from being burned



Save 300 pounds of CO<sub>2</sub> from being released into the atmosphere



Save 105 gallons of water from being consumed



## Renogy Power PLUS

Renogy Power Plus allows you to stay in the loop with upcoming solar energy innovations, share your experiences with your solar energy journey, and connect with like-minded people who are changing the world in the Renogy Power Plus community.



@Renogy Solar



@renogyofficial



@Renogy

Renogy reserves the right to change the contents of this manual without notice.



UN38.3



RoHS

